

IBIZA Bench



Colors



Seating Area



OUTDOOR



manufactured by
Cervic Environment

Bench with entire backrest

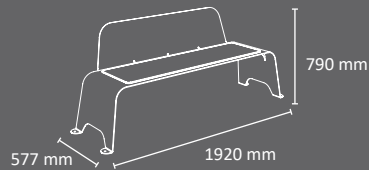

82Kg.

Bench with half backrest

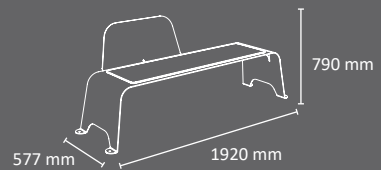

72Kg.



VERSIONS



Ibiza bench with
entire backrest



Ibiza bench with
half backrest

DETAILS



Very robust

EXAMPLES OF CUSTOMIZED COLORS (MOQ required)

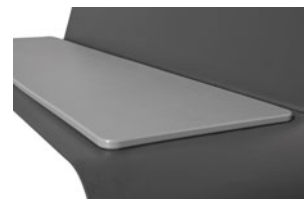
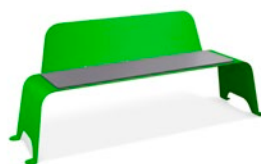

Seating Area

- Stylized and very robust bench made of steel and with technical polymer panel on the seating area.
- Available in 2 versions: bench with entire backrest, bench with half backrest.
- Made of steel with special anti-corrosion treatment, thermo-heating polyester powder coated finish and technical polymer panel on the seating area.
- Very robust (5 mm thickness) with reinforced seating area.
- Standard colors: Oxiron grey & Corten effect. Available in other colors on request (MOQ required).
- Suitable to be used indoor and outdoor.
- It can be fixed to the ground with 4 M8 expanding bolts (included).
- Guaranteed reliability: this product has satisfactorily exceeded functionality and endurance tests under real environmental and usage conditions.



REFERENCE FOR IBIZA BENCH HALF BACKREST

To process your order, all the codes that create the detailed reference must be chosen.

MODEL CODE / BACKREST LOCATION CODE / COLOR CODE



MODEL CODE

Code		Description
MPCU3811		Ibiza Bench - Half Backrest

COLOR CODE



BACKREST LOCATION CODE

Code		Description
1		Backrest on the left
2		Backrest on the center
3		Backrest on the right

REFERENCE FOR IBIZA BENCH ENTIRE BACKREST

To process your order, all the codes that create the detailed reference must be chosen.

MODEL CODE / COLOR CODE

MODEL CODE

Code		Description
MPCU3814		Ibiza Bench - Entire Backrest

COLOR CODE

Oxiron Grey

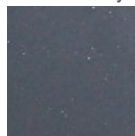

1

Corten Effect

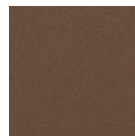

2

PACKAGING AND LOGISTIC DETAILS

Packaging details with pallet

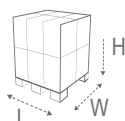

Description	u. / pallet	Type of packaging	Pallet dimensions mm*			Pallet weight	Volume
			Length	Width	Height		
biza bench with half backrest	4	shrink-wrapped	2000	800	2000	316 kg	3,2 m ³
lbiza bench with entire backrest	4	shrink-wrapped	2000	800	2000	276 kg	3,2 m ³

*The logistic could be changed in case of the loading of different products in the same pallet.
In case of full containers, trailers or trucks, ask for logistic optimization.



Ibiza bench with half backrest

Materials

- Steel with reinforced seating area.
- Polyethylene seating area.

Weight

- 72 kg

Finish

- Special treatment with anticorrosive primer rich in zinc and thermo-heating polyester powder coating.

Anchorage

- 4 M8 expanding bolts (included)

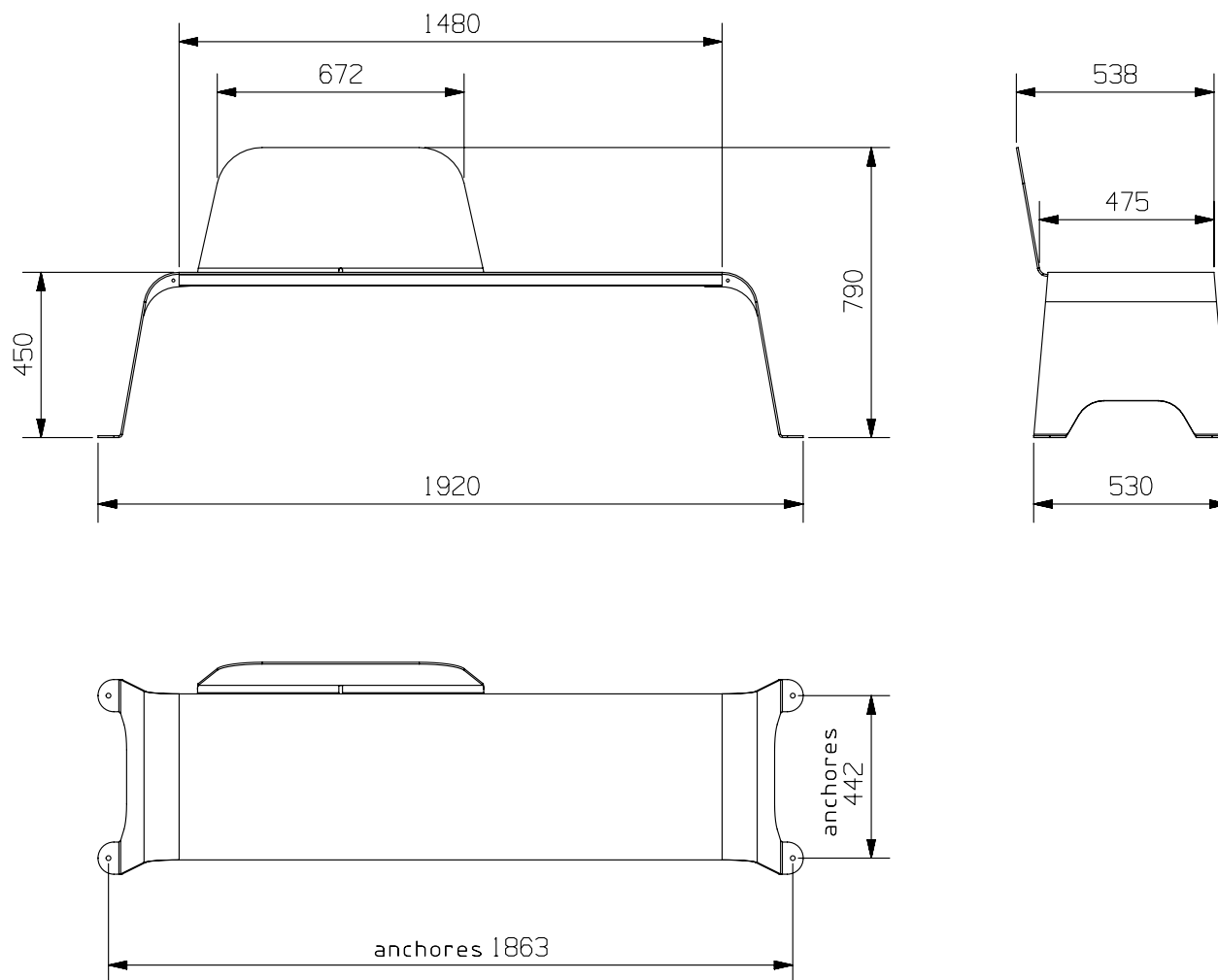



Ibiza bench with entire backrest

Materials

- Steel with reinforced seating area.
- Polyethylene seating area.

Weight

- 82 kg

Finish

- Special treatment with anticorrosive primer rich in zinc and thermo-heating polyester powder coating.

Anchorage

- 4 M8 expanding bolts (included)

